



SOLID TERMO



RVALUE



MAXIMUM
LOAD



STEPS
FLEX



PROTECTIVE
FEET



YEARS
GUARANTEE



The mark of
responsible forestry



COMPLIANCE WITH
THE STANDARD

OMAN

CLASSIC

EI

MINI

FLEX

SOLID

LONG

The SOLID TERMO loft ladder is characterised by single sealing and hatch thickness 1.02 in. SOLID TERMO model is ideally suited to conditions where the attic is poorly insulated and requires additional thermal insulation. This ladder is equipped with durable SOLID metal ladder, thanks to it the maximum load when using stairs is up to 418 lbs. Our non-slip feet included in SOLID TERMO loft ladder provide an aesthetic finish for the ladder after cutting. The excellent quality of materials used for the production of stairs and attention to every details of finish cause that the stairs will satisfy even the most demanding customers.

Technical specification

Insulated hatch thickness	1.02 in
Thickness of thermal insulation	0.79 in
Hatch colour from both sides	White
Metal ladder	3 sections
Height of wooden box	5.31 in
Width of ladder	15.7 in
Width of step	14.2 in
Depth of step	4.45 in
Landing space	58.3 in
Opening distance/angle	65.3 in
Maximum ceiling height	110.2 in

Box dimensions [in] AxB

55 x 21.5 AS. 55.11 x 21.65

Outer box dimensions, mounting opening 0.79 in larger

*Mounting a handrail is unavailable

Non-standard dimensions

Min - Max Length 43 - 55 in

Min - Max Width 21.5 - 33.5 in

*Unusual dimensions available in full size of untypical stairs can not exceed 10.76 ft²

Accessories



Masking batten



Mounting system



Hatch balustrade

Technical draw

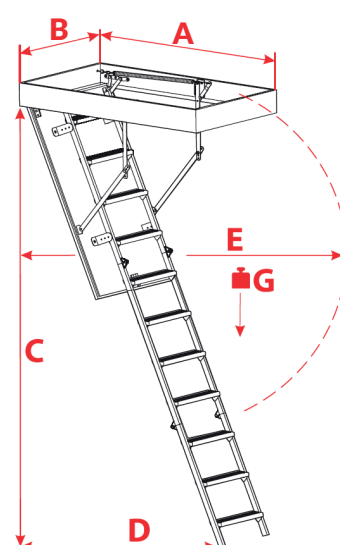

A > 39

C 110.2 in

D 58.3 in

E 65.3 in

G 418 lbs